

**BW**  
**BRITISH**  
**WIRING**  
**INC.**

**WIRE, TERMINALS & SUNDRIES**  
**CATALOG**  
**16th Edition**  
**Copyright 2004**

**Member**



---

**20449 Ithaca,**  
**Olympia Fields, IL 60461**  
**Phone/Fax (708) 481 - 9050**  
**e-mail: britishwiring@ameritech.net**  
**web Page: www.britishwiring.com**

---

# CONTENTS

<b>Item</b>	<b>Page #</b>
Assortment Packs Connectors/Grommets	8
Battery & Starter Terminals	10-11
Battery Cable & Grounding Braid	9
Bulbholders	16
Bullets & Sleeves (Snap Connectors)	15
Cable Clips	25
Dashboard Lights	16
Dimmer Switch Lead	29
Distributor Grommet	23
Fuseboxes & Fuses	20-21
Grommets	22-23
Hazard Switch	18
Headlamp Plugs & Pigtails	17 & 29
Multicore Cables & Prices	7
Multi-pin Connectors	26-27
Plugs (Headlamp, Alternator, Wiper, Dash, Washer)	17-18
Relays and Relay Housings	18-19
Resistive Wire	7
Sidelamp/Turn Signal Pigtails	29
Sleeving (PVC, Heat Shrink, Adhesive Shrink)	24
Speaker Wire	7
Steering Column Lead	29
Stickers & Labels	30-32
Tapes - Insulation & Harness	8
Terminals (Spades, Covers, Eyelets, PosiLock etc)	12-14
Thin Wall Wire Prices	7
Tools - Crimping, Closing, Wire Stripper	28
Voltage Stabiliser Unit	18
Waterproof Multipin Connectors	27
Wiper Motor Lead	29
Wire and Wire Prices	2-7

## Shipping Charges

**The following information is for items in this catalog only.** Please add 5% of total value to cover shipping and handling. **Minimum Shipping is \$4.00** for orders up to 1 lb - catalog items only. Use order form in center of catalog. A new order form will be sent with your order.

*(Harnesses ordered from separate listing sheets will have shipping added at UPS rates.)*

# WIRE

All automotive wire is made up of a number of strands of copper wire. Needless to say, the more current the wires are required to carry, the greater the number of strands it needs, so a cable designated 28/0.30 is made up of 28 strands of wire, each measuring 0.30mm in diameter. The following table shows the various sizes and the general use of the wire.

Cable Size (Strands)	Carrying Capacity (Amps)	General Use
9 14	5.75 8.00	LT Ignition. Side and Tail Lamps and General Wiring
28	17.50	Headlamps. Major Accessory Feeds
44	25.50	Generator, Control Box and Ammeter
65 84 120	35.00 42.00 60.00	Alternator feed and Ammeter

To work out what size of wire you require use the following equation:  $AMPS = Watts/Volts$

British 14 strand wire = 18 gauge US

British 28 strand wire = 14 gauge US

British 44 strand wire = 12 gauge US

British 65 strand wire = 10 gauge US

We supply two types of wire for the classic car market - PVC and Braided.

# WIRE

Braided and Lacquered wire is now manufactured to give a more authentic appearance on the older cars. This is available as well as a vast range of standard PVC wire. The Braided and Lacquered wire is made with a PVC inner core and therefore contains all of the electrical properties of modern wire.

## FOR THE FOLLOWING CABLE CHARTS: -

On the following pages we have listed the wire in the sizes and colors available. The 'P' column denotes PVC wire available and 'B' denotes Braided and Lacquered wire available. Due to restrictions on the manufacturing machinery 65/0.30 is the largest wire offered in Braided and Lacquered finish.

## A SELECTION OF WIRE IS KEPT IN STOCK.

Orders may take up to six weeks to complete when wire is ordered from the UK. Please call for information.

The following Standard abbreviations are used in the following table:

B = Black	O = Orange	U = Blue
G = Green	P = Purple	W = White
K = Pink	R = Red	Y = Yellow
N = Brown	S = Slate	LG = Lt Green

## 'Thin Wall' Wire

Although not a full range of sizes and colors yet, the modern 'thin wall' wire as used in the Automotive Industry today is available. Call for availability.

Size	Cross Section	Amps
24 / 0.2	0.75 sq mm	14.0
32 / 0.2	1.00	16.5
21 / 0.3	1.50	21.0
28 / 0.3	2.00	25.0
44 / 0.3	3.00	33.0
84 / 0.3	6.00	50.0

# WIRE

Size: 9 14 28 44 65 84 120

B	PB	PB	PB	PB	PB	P	P
BG		PB	PB	P			
BN	P						
BO	P						
BP	PB						
BR	P	PB	PB				
BS		P					
BU	PB		PB	PB			
BW	P	PB	PB	PB	P		
BY	P	PB	PB	PB	P		P
G	PB	PB	PB	PB			
GB	PB	PB	PB				
GK		P	P				
GLG	P						
GN	PB	P	P				
GO	P		P				
GP	PB	PB	PB				
GR	PB	PB	PB				
GS		P	P				
GU	PB	PB	P				
GW	PB	PB	PB				
GY	PB	PB	P	P			
LG	P		P				
LGB	P		P				
LGG	P		P				
LGK		P	P				
LGN	P	P	P				
LGO	P	P	P				
LGP	P	P	P				
LGR	P		P				
LGS		P					
LGU	P						
LGW		P	P				
LGY	P						

# WIRE

Size: 9 14 28 44 65 84 120

K		PB	PB				
KB,KG,KN,KO,KP,KR,KU,KW,KY	(14 PVC ONLY)						
N	PB	PB	PB	PB	PB	P	P
NB	PB	PB	PB	PB			
NG		PB	PB	PB			
NLG		P	P				
NO		P	P				
NP		PB	PB	PB	P		
NR		PB	PB		P		P
NS		P					
NU		P	PB	PB	P		
NW		PB	PB	PB	PB	P	P
NY	PB	P	PB	PB			P
O,OB,OG,OLG,OS,OU,OW,OY	(14 PVC ONLY)						
P	PB	PB	PB	PB	P		
PB	PB	PB	PB				
PG	P	PB	P				
PK		P					
PN		P					
PO		P	P				
PR		PB	P				
PU	PB	P	P				
PW	PB		PB				
PY		PB	PB	PB			
R	PB	PB	PB	PB	PB	P	
RB		PB	PB	PB			
RG	PB	PB	PB	P			
RLG		P	P				
RN	PB		PB				
RO	P						
RP	P		P				
RU	P	PB	PB	PB	P		
RW	PB	PB					P
RY		PB	PB	PB			

# WIRE

	Size:	9	14	28	44	65	84	120
S			PB	PB	P			
SB			PB	P				
SG			PB	P	P			
SP			P	PB				
SR			PB	P				
SU			P	P				
SY		P	P	P				
U			PB	PB	PB	P		
UB			PB	PB				
UG			PB	PB	PB			
UK			P	P				
ULG			P	P				
UN			P	PB				
UO			P	P				
UP		PB	P	PB				
UR			PB	PB	PB			
US			P	P				
UW		PB	PB	PB	PB			
UY			PB	PB	P			
W		PB	PB	PB	PB	P		
WB		PB	PB	PB	PB			
WG			PB	PB				
WK			P	P	P			
WLG			P	P				
WN		PB	PB	P	P			
WP		PB	PB	PB	PB			
WR			PB	PB	PB	P		
WU		P	PB	PB		P		
WY		PB		P	P			
Y		PB	PB	PB	PB	PB		P
YB		P	PB	PB	PB	PB		
YG		PB	PB	PB				
YLG			P					
YN		P	PB	P	P			
YP		P	PB	PB				
YR		P	PB	PB	PB	P		
YU			PB	P				
YW			PB	P	P	P		

# WIRE PRICING

<b>PVC Wires</b> (see page 2 for equivalent US gauge wire sizes)		Per Metre	Per 50m
109	9 Strand	.50	25.00
114	14	.65	32.50
128	28	.90	45.00
144	44	1.05	52.50
165	65	2.10	105.00
184	84	2.60	130.00
120	120	3.00	150.00
112	Speaker Cable (B/BW)	.70	35.00

### Braided (& Lacquered) Wires

409	9 Strand	1.45	72.50
414	14	1.65	82.50
428	28	2.00	100.00
444	44	2.65	132.50
465	65	4.00	200.00

### Braided Wire - non stock colors

Provided a minimum order of 10 metres is placed any color can be produced to order. (Only upto 65/0.30)  
Allow extra time for delivery.

<b>Thin Wall Wire</b>			Per Metre	Per 50m
624	24 / 0.2	14.0 amps	.55	27.50
632	32 / 0.2	16.5 amps	.65	32.50
628	28 / 0.3	25.0 amps	.85	42.50
644	44 / 0.3	33.0 amps	1.10	55.00
684	84 / 0.3	50.0 amps	2.10	105.00

### Multicore Cables

901	2-core 9 strand	Red & Black	.65	32.50
902	2-core 14 strand	Red & Black	.90	45.00
903	2-core 28 strand	Red & Black	1.35	67.50
904	3-core 9 strand	Red & Black	1.20	60.00
905	3-core 14 strand	R, B & Green	1.70	85.00
906	3-core 28 strand	R, B & Green	2.55	127.50
907	7-core 9 strand	(trailer lead)	1.80	90.00

R/B/G/Y/N/W/U

**New Resistive or "Eureka" wire, per ft. 1.50**

## Harness Tape & Assortment Packs

**Harness Tape.** Self-bonding, PVC but not self-adhesive, 20 metre roll.

		Per Roll
453	3/4" Wide - black	3.00
454	1" Wide - black (no longer available)	---
455	3/4" Wide - blue	4.00
459	3/4" Wide - grey	5.50

### Cloth Insulation Tape

451	3/4" Wide-black cloth with adhesive 12.5 meters (41 feet) per roll.	6.00
-----	--	------

**Assortment Packs.** Selections of the most popular part numbers in each category.

SP1	Spades and covers 5 x 232, 5 x 233, 10 x 221, 10 x 223, 20 x 222,	50 pieces	9.25
BG1	Blanking grommets 6 x 543, 4 x 544, 2 x 545, 2 x 546, 2 x 548	16 pieces	5.20
GS1	Grommets 4 x 501, 5 x 502, 4 x 505, 3 x 503, 2 x 552, 2 x 555	20 pieces	28.10
CC1	Cable clips 5 x 947, 5 x 950, 4x 952 1 x 953	15 pieces	23.55
CB1	Solder bullets & sleeves 10 x 311, 5 x 312, 30 x 301, 5 x 302	50 pieces	15.50
CB2	Crimp bullets & sleeves 10 x 311, 5 x 312, 6 x 309, 20 x 314, 10 x 328, 3 x 344 (Can also solder these bullets)	54 pieces	13.10

## BATTERY CABLES

*For pre-assembled battery cables with terminals on both ends- see harness lists*

		Per Foot
<b>PVC Battery Cable</b>		
137	37 Strand Black	2.50
138	37 Strand Red - Special Order	2.50

Cable below is for heavy duty use or where a long cable run is required (e.g. battery at the rear of car)

161	61 Strand Black	4.50
163	61 Strand Red - Special Order	4.50

### Braided Battery Cable

For authenticity on early cars, a braided version of the PVC cable is available in black braid only. (Use 139 for Austin Healey concours spec.)

139	37 Strand - 7/16" OD	4.00
162	61 Strand - 1/2" OD	6.00

### Grounding Braid



		Per Foot
116	16/16 16 strands of size 16 Copper wire. (Use with 137,138,139 size cable)	2.60
132	16/32 16 strands of size 32 Copper wire. (Use with 161,162,163 size cable)	6.00

### For suitable cable clips use (page 25)

	Outer Diameter	Clip Number
37 Strand	9.7 mm	949, 950, 964
61 Strand	11.8 mm	951, 952

# BATTERY TERMINALS

## Battery Terminals & Covers

All plated brass except 991&992 Each

To suit all cable sizes.

365 Negative Screw-down. 3.75  
 366 Positive Screw-down. 3.75

To suit #137, #139 & #116 cables

369 Negative Solder Type 6.15  
 370 Positive Solder Type 6.15

To suit #161, #162, & #132 cables

372 Negative Solder Type 6.15  
 373 Positive Solder Type 6.15

To suit Terminals 365 to 373 above:

376 to 379 Battery Terminal Covers 2.15

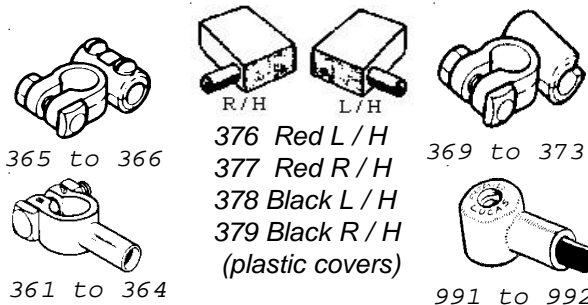

To suit #137, #139 & #116 cables Each

361 Negative Solder Type 6.15  
 362 Positive Solder Type 6.15

To suit #161, #162, & #132 cables

363 Negative Solder Type 6.15  
 364 Positive Solder Type 6.15

To suit #137, #139 & #116 cables

991 Negative Solder Type- cast bronze 22.00  
 992 Positive Solder Type- cast bronze 22.00  
 993 Screws for 991/992 0.50

# BATTERY TERMINALS

## Ring Terminals

To fit Starter, Solenoid and Grounding Points:

To suit #137, #139 & #116 cables Each Per 50

281 1/4" Hole 1.20 60.00  
 282 5/16" Hole 1.20 60.00  
 283 3/8" Hole 1.20 60.00  
 289 Boot for above 1.15 57.50

1600 5/16" Hole, right angle type 2.70 135.00

292 5/16" Flag-type 1.60 80.00  
 293 3/8" Flag-type 1.60 80.00

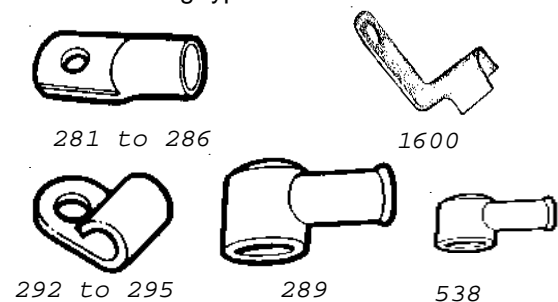

To suit #161, #162, & #132 cables Each Per 50

284 1/4" Hole 1.50 75.00  
 285 5/16" Hole 1.50 75.00  
 286 3/8" Hole 1.50 75.00  
 289 Boot for 281 to 286 1.15 57.50  
 295 5/16" Flag-type 1.60 80.00

## Terminal Boot

538 Small Boot to suit 3/16 eye on coils etc. (Same design as #289 above) 1.10 55.00

# TERMINALS

## Spade Terminals

For crimping tools see page 28

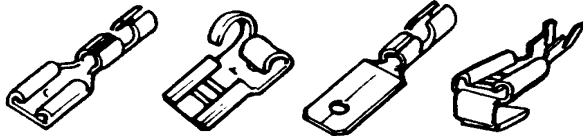

Type A    Type B    Type C    Type D

	Type	Max wire		Each	Per 50
<b>1/8"</b>					
201	A	14	use with speakers	.20	10.00
<b>3/16</b>					
206	A	28		.20	10.00
208	B	28		.30	15.00
210	C	28		.45	22.50
211	A	28	use in housings	.20	10.00
<b>1/4"</b>					
221	A	14		.20	10.00
223	A	28		.20	10.00
224	A	65		.20	10.00
226	A	28	use in housings	.30	15.00
232	B	28		.30	15.00
227	C	28		.25	12.50
228	A	65	use in housing	.30	15.00
229	D	28	"piggy back"	.30	15.00
234	C	28	use in housings	.30	15.00
235	C	65	use in housings	.30	15.00

"use in housings" means spade has a little barb on the back to lock into place with plastic housings.

## 3/8"

241	A	65		.35	17.50
243	B	44		.35	17.50
245	C	65		.55	17.50

## 1/2"

247	A	120		1.20	60.00
249	C	120		1.20	60.00

# TERMINALS

## Connecting Terminals



200



994

	Each	Per 50
200 1/4" Male Blade	.50	25.00
994 1/4" Double Blade	.50	25.00

## Posi-Lock Spade Terminal

1/4" spade. If the wire is pulled it will not detach. It is removed only by pulling on the cover which operates a lever action inside. (mid 70's - on)



219



220

219 1/4" Posi-lock spade	.35	17.50
220 1/4" Black posi-lock cover	.20	10.00

## Covers for Spade Terminals

995 1/4" Rigid white plastic cover, similar to the 220. For 1/4" spades including 226 & 228	.20	10.00
---	-----	-------

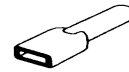

222



233

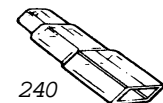

240

Size	To suit Terminal:	Each	Per 50
202 1/8"	201	.15	7.50
207 3/16"	206 & 210	.15	7.50
209 3/16"	208	.15	7.50
222 1/4"	221,223,227&229	.15	7.50
225 1/4"	224	.15	7.50
233 1/4"	232	.15	7.50
240 1/4"	extended cover for 227	.50	25.00
242 3/8"	241	.25	12.50
244 3/8"	243	.25	12.50
248 1/2"	247	1.70	85.00

# TERMINALS

## Standard Eyelets

For wires up to 28 strand		Each	Per 50
251	1/8"	.30	15.00
252	3/16"	.30	15.00
253	1/4"	.30	15.00
254	5/16"	.30	15.00
255	3/8"	.30	15.50
For wires over 28 strand		Each	Per 50
256	3/16"	.30	15.00
257	1/4"	.30	15.00
258	5/16"	.30	15.00
259	3/8"	.30	15.00
260	1/2"	.45	22.50

**Rubber Insulation Sleeves: 1 inch long to suit all straight terminals (not flag). Will stretch to much larger diameter to fit.**

261	1/16" i.d. for smaller diameter wires	.15	7.50
261L	1/8" i.d. for larger diameter wires	.15	7.50
538	Boot for 3/16 eye on coil etc. - see picture on page 11.	1.10	55.00



251-259      262-263      264      272

## Fork Terminals

		Each	Per 50
262	3/16" Up to 28 strand wire	.40	20.00
263	3/16" Over 28 strand wire	.40	20.00
264	3/16" Flag-type	.60	30.00

## Flag-type Eyelets

272	3/16" For wires up to 28 strand	.40	20.00
-----	---------------------------------	-----	-------

# BULLETS & SNAP CONNECTORS

## Bullet Connectors

For crimping or soldering:		Each	Per 50
309	to fit 9 strand pvc wire	.15	7.50
314	to fit 14 strand pvc wire	.15	7.50
328	to fit 28 strand pvc or braid wire	.15	7.50
344	to fit 44 strand pvc or braid wire	.15	7.50
317	to fit 9 strand braided wire	.15	7.50
318	to fit 14 strand braided wire	.15	7.50

## Bullet Connectors

Suitable for soldering only:		Each	Per 50
301	to fit wire up to 28 strand	.25	12.50
302	to fit wire over 28 strand	.25	12.50

## Loose Sleeve Bullets

303	not currently available	----	----
-----	-------------------------	------	------

## Grounding Clip

990	Stainless steel construction	4.00	
-----	------------------------------	------	--

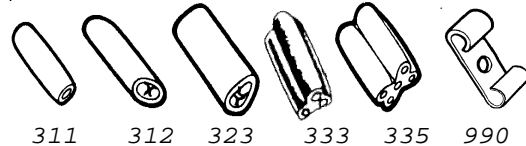

## Snap Connector Sleeves

		Each	Per 50
311	Single sleeve (joins 2 bulletted wires)	.45	22.50
312	Double (joins up to 4 bulletted wires)	.55	27.50
323	Triple (joins up to 6 bulletted wires)	2.75	----
324	Four-way (joins up to 8 wires)	4.00	----
333	Three-way (3 wires each isolated)	5.50	----
335	Five-way (for 5 wires each isolated)	5.50	----
336	Ten-way - Jaguar applications (as 335 but with 5 isolated doubles)	12.00	----

## 4 mm Bullets European & Japanese Cars

306	Male Bullet and Cover	.35	17.50
307	Female Bullet and Cover	.35	17.50



# BULBHOLDERS

- Clip-in Bulbholders to fit 5/8" hole.** Each
- 611 A single contact for center of bulb. Grounded through body of bulbholder. (e.g. Panel lights which only need a ground.) 4.60
- 612 Fixing Ring is isolated from body of bulbholder. It has a separate contact for second wire. (e.g. Ignition Warning light which does not go to ground.) 4.60
- LLB987 Screw-in bulb for 611 & 612 holders 1.25

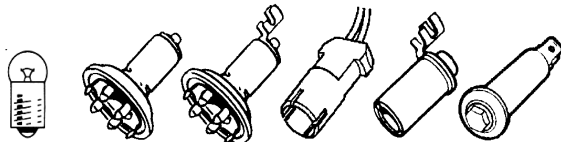

LLB987 611 612 614 615 617-20

- Push-in Bulbholders- to fit 1/2" tube** Each
- 614 Plastic bulb holder, has two wire contacts. Normally fitted in a plastic tube. Includes LLB504 bulb. 3.20

- LLB504 3 watt bulb for 614 to use in dash lamps (halogen) 1.25



LLB504

## Dashboard Warning Lights

- 615 **To fit a 3/8" Tube** with contact for 2nd wire, takes LLB281. 3.50

- LLB281 BA7 bulb for 615 holders 1.25



LLB281

- To fit 1/2" hole**, has two 1/4" spade fittings, has bulb built in.
- 617 Green bulbholder assembly 3.50
- 618 Blue bulbholder assembly 3.50
- 619 Red bulbholder assembly 3.50
- 620 Amber bulbholder assembly 3.50

# PLUGS (Supplied with Terminals)

- 3-Pin Type Headlamp Plug** Each
- 808 Plug for standard sealed seam unit with terminals 3.50
- 812 Plug as above (808) that also has an under slung sidelamp fitting, with terminals 6.20
- 2450 Extra terminals for 808 or 812 .40

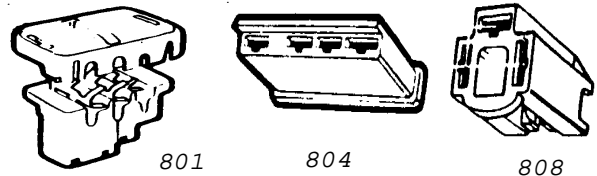

801

804

808

- Alternator Plugs** Each
- 801 Standard Lucas Single Plug for 16ACR alternators (supplied with terminal set of 3/8", 3/8" & 1/4" spades). 4.50

- 801T Additional terminal set for the 801 1.20

- 804 4TR Alternator Regulator Unit 2.75

- 9401 XKE S3,V12 Ignition Amplifier Plug (similar to 804 but with "key" slot) 2.75

## Wiper Motor Plug

- 805 Standard Lucas Two-Speed 3.00

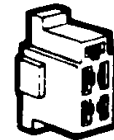

805

- 211 Extra terminals for 805 .20

## Washer Pump Plug

- 841 Standard Washer Pump Plug - (Two 1/4" spade terminals forming a 'T' shape, comes with terminals) 1.60



841

# Dash Components, Relays & Housings

## Dash Plugs, Hazard Switch, Voltage Stabilizer

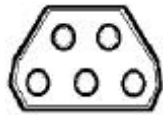

836



835

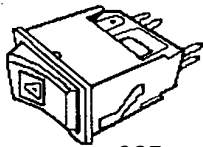

837

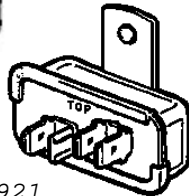

921

- |     |  |       |      |
|-----|--|-------|------|
| 835 | Plug for Hazard Warning Switch with 5 or 6 pins. Has 3mm round pins on back. (Lucas 152SA) | 4.50  | Each |
| 836 | For other switches with 3mm round pins on back. (Lucas 159SA)                              | 3.00  |      |
| 837 | Hazard switch with pins, use with 835 plug   | 30.00 |      |
| 921 | Voltage stabilizer unit, cars 1967-on  | 18.00 |      |

## Relays and Housings



156



157



158



159

- |     |  |       |      |
|-----|--|-------|------|
|     |  |       | Each |
| 156 | 2-pole flasher relay                                 | 13.75 |      |
| 157 | 3-pole flasher relay                                 | 14.50 |      |
| 158 | Housing for 156, 157 or 159, supplied with terminals | 3.50  |      |
| 159 | 2-pole hazard flasher relay                          | 13.50 |      |

# Relays & Housings



816



817

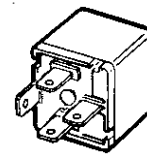

818

- |     |  |       |      |
|-----|--|-------|------|
| 814 | Four-way relay base housing. Can be used with fusebox 151.   | 30.00 | Each |
| 816 | Single housing for 818 & 820 relays. Without mounting bracket. Supplied with terminals.  | 2.50  |      |
| 817 | Housing with bracket which will "tongue and groove" together in line. Fuseholder #146 will also link in. Fits 818 & 820. With terminals. | 3.25  |      |
| 818 | Standard 12 volt relay for horns, fan, headlamps etc. 4 pin on/off. DPDT (double pole double throw)                                      | 8.00  |      |

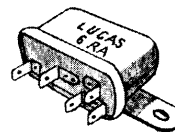

819

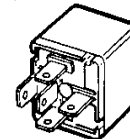

820

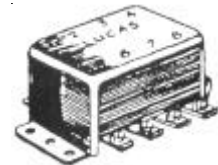

DB10

- |      |  |        |      |
|------|--|--------|------|
| 819  | Lucas 6RA 4-pin relay. One "pin" has connectors for 2 wires.   | 28.00  | Each |
| 820  | 5-pin changeover relay, SPDT (single pole double throw)  | 11.50  |      |
| DB10 | Eight-way relay for turn signals   | 145.00 |      |
| 2073 | XJ, TR7/8 relay housing similar to 817. Slots onto metal plate. Fits 818 relays. Supplied with terminals | 3.25   |      |

# FUSEBOXES

## Glass Fuses

			Each	per 50
110	10 Amp		.40	20.00
115	15 Amp		.40	20.00
125	25 Amp		.40	20.00
135	35 Amp		.40	20.00
150	50 Amp		.50	25.00

## Blade Fuses

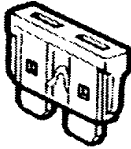
			Each	per 50
171	5 Amp		.25	12.50
172	7.5 Amp		.25	12.50
173	10 Amp		.25	12.50
174	15 Amp		.25	12.50
175	20 Amp		.25	12.50
176	25 Amp		.25	12.50
177	30 Amp		.25	12.50

## Single Fuse Holders

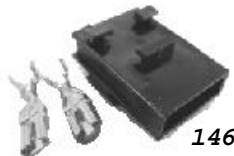

141	In-line type for glass fuses.	Each	per 50
146	Blade fuseholder to attach to side of Relay Housing # 817 (Use as many as required)	1.35	67.50



1401	Replacement clamp style holder, glass fuses - need 4 per fuse.	Each	0.60
------	--	------	------

## Fusebox - 2 way

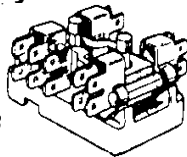
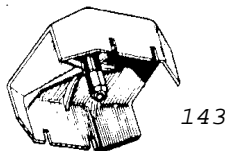

143	Lucas 2-way fusebox, for glass fuses & spade terminals, with cover	Each	25.50
-----	--	------	-------

# FUSEBOXES

## Fuseboxes - 3,4,6,12,16 way

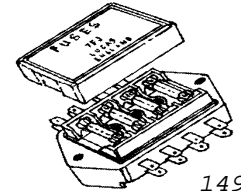
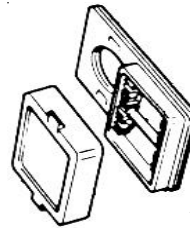

153	Three way fusebox, glass fuses, for Spitfire and others - if a new grommet is needed, it takes a # 552 (page23)	Each	49.00
149	Lucas 7FJ 4 -way fusebox to take glass fuses - <b>side entry</b>		34.00
152	Lucas 7FJ 4 -way fusebox to take glass fuses - <b>rear entry</b>		43.00



147	4-way fusebox to take blade fuses	Each	7.00
148	6-way fusebox to take blade fuses		7.50
140	Lucas 12-way fusebox, for glass fuses, spade terminals, (not shown)		40.00

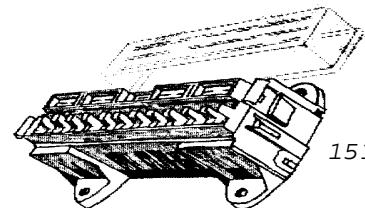

151	16-way fusebox to take blade fuses, 5"long, 2" wide and 3 1/2" wide including fixing brackets. Can be used with 4-way relay base housing # 814.	Each	30.00
-----	---	------	-------

# GROMMETS

## PVC Grommets

"A" = Size of hole grommet fits, not its diameter.

	Hole "A"	Bore "B"	Each	Per 50
521	1/4"	5/32"	.25	12.50
522	5/16"	7/32"	.25	12.50
525	3/8"	5/16"	.25	12.50
526	7/16"	5/16"	.25	12.50
527	1/2"	5/16"	.25	12.50
529	5/8"	7/16"	.25	12.50
530	11/16"	1/2"	.25	12.50
531	3/4"	1/2"	.30	15.00
533	1"	3/4"	.65	32.50
534	1-1/4"	1"	.65	32.50

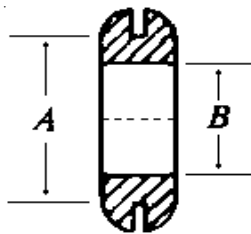

521 to 534

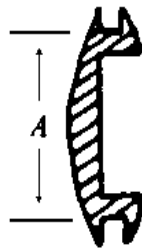

541 to 550 & 558

## Blanking Grommets

	Hole "A"	Each	Per 50
541	1/4"	.25	12.50
542	5/16"	.25	12.50
543	3/8"	.25	12.50
544	1/2"	.30	12.50
545	5/8"	.35	12.50
546	3/4"	.40	25.00
547	7/8"	.50	25.00
548	1"	.50	25.00
549	1 1/4"	.80	40.00
550	1 1/2"	.90	45.00
558	2"	1.30	65.00

# GROMMETS

## Rubber Grommets

	Hole "A"	Bore "B"	Each	Per 50
501	1/2"	1/8"	.85	42.50
502	3/4"	1/8"	.95	47.50
505	1"	7/32"	1.75	87.50
503	1-1/4"	5/32"	1.45	72.50
507	1-1/4"	3/8"	1.75	87.50
504	1-1/4"	5/8"	2.20	110.00
509	1-3/8"	1/2"	2.10	105.00
510	1-1/2"	1/2"	2.75	137.50
508	1-3/4"	3/8"	2.75	137.50
506	1-3/16"	9/32"	5.75	287.50

All of the above Grommets except 506 are suitable for standard metal panels. 506 allows for a 1/4" panel and is therefore ideal for use in fiberglass. All grommets have a "semi-blind" center so the bore size shown is a minimum but can be stretched to suit.

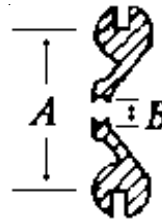

501 to 510

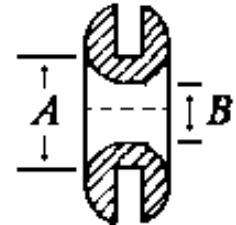

551 to 555

	Hole "A"	Bore "B"	Each	Per 50
551	1/2"	1/4"	1.20	60.00
552	3/4"	1/2"	1.45	72.50
553	1"	3/4"	1.55	77.50
554	1-1/4"	1"	1.75	87.50
555	1-1/2"	1-1/4"	2.85	142.50

## Distributor Grommet

540	Low tension lead grommet for the standard Lucas distributor		.55	27.50
-----	---	---	-----	-------

540

# SLEEVING

## PVC Sleeving

Sleeving is ideal for lengths of wiring where extra protection is required. The sleeving is made from a high grade PVC and has a good resistance to oil, water, and acid.

		14 strand PVC wires	28 strand PVC wires	14 strand braid wires	28 strand braid wires	Per Metre
703	3 mm	1	0	0	0	.30
704	4 mm	1	1	1	0	.45
705	5 mm	2	1	1	1	.55
706	6 mm	3	2	2	1	.60
708	8 mm	4	3	3	2	.90
710	10 mm				3	1.00
712	12 mm					1.50
714	14 mm					1.85
716	16 mm					2.25
718	18 mm					2.45
720	20 mm					2.55
725	25 mm					3.40

The 'wires' column is a guide to how many wires will pass through. Make allowances for larger cables or very long runs.

**Heat shrink sleeving:** Inside diameter before heating. Shrinks to 1/2 this size. Per Metre

723	3 mm	(1/8")	.95
726	6 mm	(1/4")	2.00
729	9 mm	(1/3")	2.70
732	12 mm	(1/2")	3.00
739	19 mm	(3/4")	4.00

**Adhesive heat shrink sleeving:** Inside diameter before heating. Shrinks to 1/3 this size.

746	6 mm	price per 2 ft. length	2.40
752	12 mm	price per 2 ft. length	3.20
759	18 mm	price per 2 ft. length	7.00
764	24 mm	price per 2 ft. length	9.00

# CABLE CLIPS

## Cable Clips - Nickel Plated



943 to 955

	Fixing Hole	Cable Dia.	Each	Per 50
943	3/16"	3/16"	not currently available	
947	3/16"	9/32"	1.40	70.00
948	11/32"	9/32"	1.50	75.00
949	9/32"	3/8"	1.65	82.50
950	3/16"	3/8"	1.65	82.50
951	11/32"	7/16"	1.65	82.50
952	3/16"	1/2"	1.65	82.50
953	3/16"	5/8"	1.70	85.00
954	5/16"	5/8"	1.70	85.00
955	11/32"	5/8"	1.90	95.00

## Cable Clips (Black PVC)



961 to 974

	Fixing Hole	Cable Dia.	Each	Per 50
961	9/64"	3/16"	.30	15.00
962	9/64"	1/4"	.30	15.00
963	9/64"	5/16"	.30	15.00
964	9/64"	3/8"	.30	15.00
965	9/64"	7/16"	not currently available	
966	9/64"	1/2"	.45	22.50
968	9/64"	9/16 - 5/8"	.75	37.50
971	9/64"	11/16" - 1"	.80	40.00
974	9/64"	7/8" - 1"	.85	42.50

# MULTI-PIN CONNECTORS

*Examples*

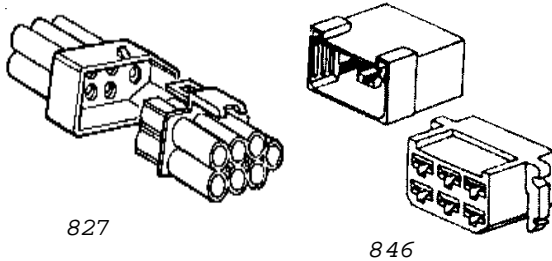

Assemblies are supplied with the two mating halves and correct number of terminals.  
**Terminals may be purchased separately.**  
**See next page.**

<b>3mm Pin &amp; Socket type</b>		Each
821	1 - Way Assembly	2.20
822	2 - Way Assembly	2.75
823	3 - Way Assembly	3.25
824	4 - Way Assembly	4.00
825	5 - Way Assembly	4.70
827	7 - Way Assembly	6.40
829	9 - Way Assembly	7.00

<b>1/4" Spade &amp; Tab Type</b>		Each
842	2 - Way Assembly	2.35
843	3 - Way Assembly	2.75
844	4 - Way Assembly	3.10
846	6 - Way Assembly	4.00
848	8 - Way Assembly	9.20
851	11 - Way Assembly	10.50
852	11 - Way Assembly with flange for panel mounting	15.75

# MULTI-PIN CONNECTORS



<b>Waterproof Multiway 3mm Pin &amp; Socket type</b>		Each
853	3-Way	9.50
855	5-Way	11.00
857	7-Way	13.00
859	9-Way	14.00

<b>Terminals: Pins and Sockets for # 821 to # 829 &amp; # 853 to # 859.</b>		Each
<b>May be ordered separately.</b>		
831	Pin terminal upto 14 strand wire	.35
832	Socket terminal upto 14 strand wire	.35
833	Pin terminal over 14 strand wire	.35
834	Socket terminal over 14 strand	.35

<b>Terminals: Spades and Tabs for # 842 to # 852.</b>		Each
<b>May be ordered separately.</b>		
226	1/4" Female up to 28 strand wire	.30
228	1/4" Female over 28 strand wire	.30
234	1/4" Male up to 28 strand wire	.30
235	1/4" Male over 28 strand wire	.30

## TOOLS



- TT85 A heavy duty ratchet style hand crimping tool for bullets. Extremely efficient hexagonal crimp. 55.00

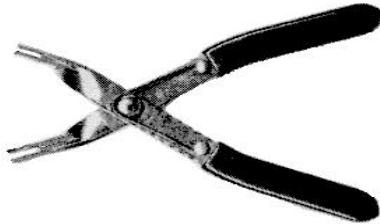

- SSC1 A plier type tool that snaps bullet wires into snap connectors in seconds. 30.00



- PR4 A heavy duty ratchet style spade crimper. Accommodates three sizes of spades and crimps terminal and insulation at the same time. 50.00



- AST4 Wire stripper and crimping tool for spade type terminals. Not for use with bullets. 12.00

## PIGTAILS & LEADS

**Headlamp Pigtails:** A headlamp **plug** (p.17) & 35" **UW,UR & B** wires, grommet, **sleeve** & bullets. Chart below reads P for PVC and B for Braid.

	UW	UR	B	Plug	Sleeve	Each
141	P	P	P	808	P	11.00
141BB	B	B	B	808	B	18.00
141XB	B	B	P	808	B	17.00
141XP	B	B	P	808	P	14.00
813	P	P	P	812	P	17.50

### Turn/side Lamp Pigtails. (2)

36" length of wires (**GW,R,B**) for RHS and (**GR,R,B**) for LHS with 30" **sleeve** and bullets one end, cut to fit other end. Chart below reads P for PVC and B for Braid.

	GW	GR	R	B	Sleeve	Pair
BW51PP	P	P	P	P	P	14.00
BW51XP	B	B	B	P	P	16.00
BW51XB	B	B	B	P	B	18.00

### Steering Column Lead

A 4-Core steering column harness which caters for indicators and horn. This is thin wall PVC wire with a tighter & thinner gauge braid to ensure fit down the stator tube. The wire colors are N/B, G/N, GW, & G/R. Other core sizes can be made to order.

104 4-core lead with terminals per ft. 4.65

### Dimmer Switch Lead

Dimmer switch extension lead which is used to connect a floor mounted dimmer switch to the main harness. Made in a similar style to the steering column harness, this comes with Blue, Blue/White, and Blue/Red Wires.

102 Forks one end & bullets other per ft. 3.60  
103 Spades one end & bullets other per ft. 3.60

### Wiper Motor Lead

A braided 2-core Purple & Black wiper motor lead which is designed to fit around the windscreen on older cars.

105 2-core wiper motor lead per ft. 2.70

# STICKERS

Web page has color pictures

ST111  
\$ 3.00  
3" by 2"

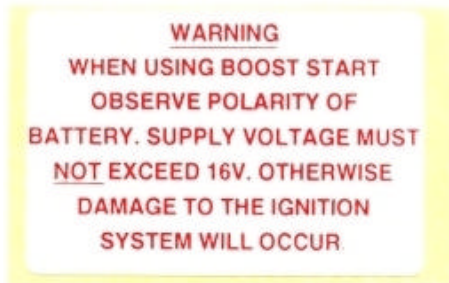

ST113  
\$ 3.00  
4" by 1"



ST115  
\$ 4.50  
4" by 2"



ST122  
\$ 7.50  
for block of 5 labels.  
0.75" by 6.5" each  
label



# STICKERS

Web page has color pictures

ST128 \$ 2.50 2.75" by 0.5"



ST129 \$ 2.50 2.75" by 0.75"



ST130 \$ 2.50 2.75" by 0.75"

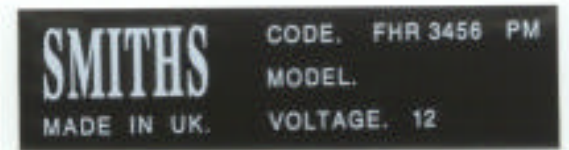

ST156 \$ 4.00 3" by 1"



ST172 \$ 4.00 4" by 1"





# STICKERS

Web page has color pictures

# NOTES

ST200

\$ 9.00

for set of 3 labels,  
top 5.25" by 2.25"  
middle 4.75" by 2.5"  
bottom 4.25" by 1.25"



ST270 \$ 4.00

2.5" by 1"



ST272

\$ 3.00

1.5" by 5.75"



ST990 \$ 8.00

2.75" by 1.25"

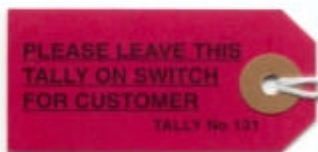

Front



Back

Qty	Part #	Wire Color / Description	Price Each	Total Price
Please use reverse side if required			From Other Side	
Name _____			Merchandise Sub-Total	
Street _____			Shipping (Page 1) Minimum \$4.00	
City, St, Zip _____			SUB-TOTAL	
E-mail _____			IL Residents 7.75%	
			TOTAL	

Payment By:  Visa     MasterCard     Discover     Check/Money Order

Card Number

**Minimum Credit Card Order: \$ 20.00**

Valid Through

Checks Payable to: **British Wiring**  
 Mail to: **20449 Ithaca Road**  
**Olympia Fields, IL 60461**  
 phone: **708-481-9050**  
 web page: **www.BritishWiring.com**  
 e-mail: **BritishWiring@Ameritech.net**

Day time phone (    ) -  
 Evening phone (    ) -  
 Fax number (    ) -

Signature \_\_\_\_\_